



ΚΩΔΙΚΟΣ ΠΡΟΪΟΝΤΟΣ : CB10641WH



















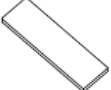

Πτυσσόμενο Γραφείο Εξοικονόμησης Χώρου με Ρυθμιζόμενη
Επιφάνεια Εργασίας

Πριν Ξεκινήσετε

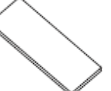
- Παρακαλούμε διαβάστε προσεκτικά όλες τις οδηγίες.
- Φυλάξτε τις οδηγίες για μελλοντική αναφορά.
- Διαχωρίστε και μετρήστε όλα τα εξαρτήματα και τα υλικά συναρμολόγησης.
- Διαβάστε προσεκτικά κάθε βήμα και ακολουθήστε τη σωστή σειρά συναρμολόγησης.
- Συνιστούμε, όπου είναι δυνατόν, η συναρμολόγηση να γίνεται κοντά στο σημείο όπου θα χρησιμοποιηθεί το προϊόν, ώστε να αποφεύγεται η άσκοπη μετακίνησή του μετά τη συναρμολόγηση.
- Τοποθετείτε πάντα το προϊόν σε επίπεδη, σταθερή και ασφαλή επιφάνεια.
- Κρατήστε όλα τα μικρά εξαρτήματα και τα υλικά συσκευασίας μακριά από βρέφη και παιδιά, καθώς ενδέχεται να αποτελούν σοβαρό κίνδυνο πνιγμού.

PARTS LIST/TEILELISTE/LISTE DES PIÈCES/
LISTA DE PIEZAS/ELENCO DELLE PARTI/LISTA ELEMENTŌW/
ONDERDELENLIJST

A		x 8	F		x 4
B	 3*14mm	x 56	G		x 6
C	 4*25mm	x 2	H	 8*30mm	x 2
D	 4*50mm	x 12	I	 8*20mm	x 2
E		x 4	J		x 2

1		x 1	5		x 1
2		x 1	6		x 1
3		x 1	7		x 1
4		x 2	8		x 1

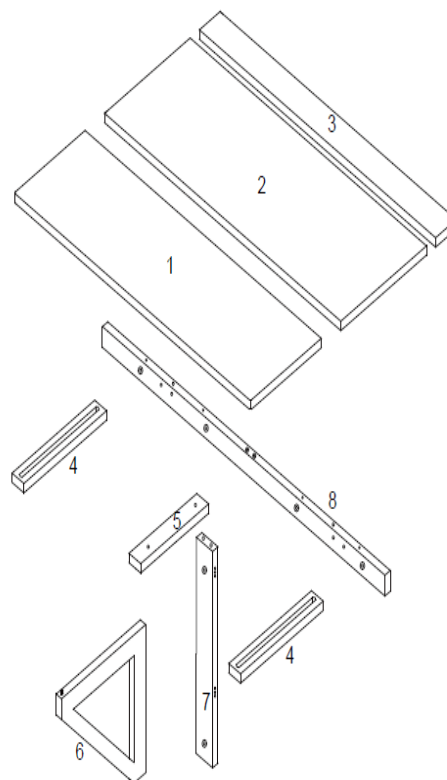

1	A		x 6
	B		x 36

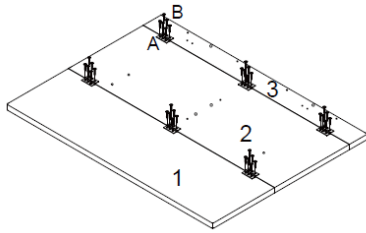

3	D		x 2
---	---	---	-----

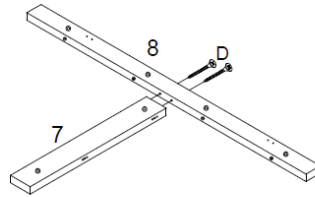

2	C		x 2
	E		x 4
	F		x 4
	I		x 2

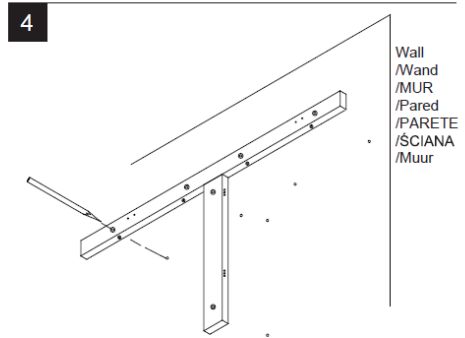
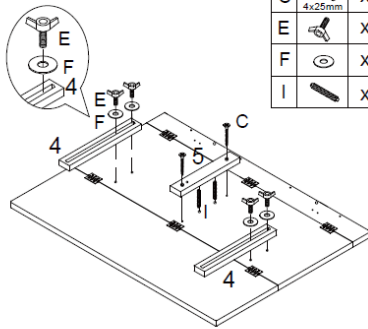

5	D		x 4
	H		x 2

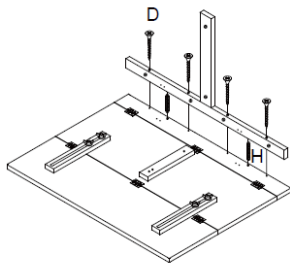

7	B		x 14
	J		x 2

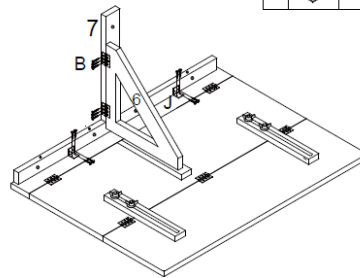

6	A		x 2
	B		x 6

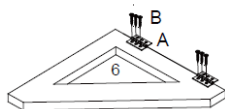

8	D		x 6
	G		x 6

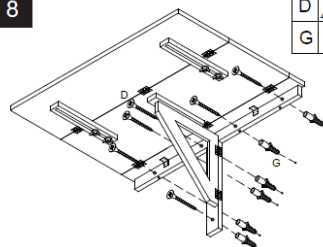

⚠ Προειδοποίηση

Βεβαιωθείτε ότι το ούπα / στήριγμα αγκύρωσης εφαρμόζει σταθερά και με ασφάλεια στον τοίχο.

Εξάρτημα:

- J × 2
- Βίδες 4 × 50 mm

9

